

Diade equipped troughs Gun Metal



Equipped troughs

Code: 8100 836



DETAILS

Edge/Installation Type Flush-mount | Top-mount | Undermount

Material AISI 304 stainless steel

Texture Brushed in line

Finish PVD

Coloring Gun Metal

Base 90 cm

External dimensions 320 x 164 mm

Internal dimensions 280 x 124 mm

Width 32 cm

Built-in hole

[View sink technical data sheet](#)

Standard fittings

Fixing hooks, gasket, drain, boxed packing

Waste fitting

1¼" drain

FEATURES

Gun Metal

The Gun Metal finish is obtained by treating steel with a physical process called PVD (Physical Vacuum Deposition) which deposits particles of noble metals on the surface. The result is a unique and refined aesthetic effect, and an improvement of the mechanical properties of the steel which is more resistant to impact and scratches.

High thickness

1mm thick steel. A significant thickness, which guarantees the maximum sturdiness and durability.

TECHNICAL DATA

8100 836

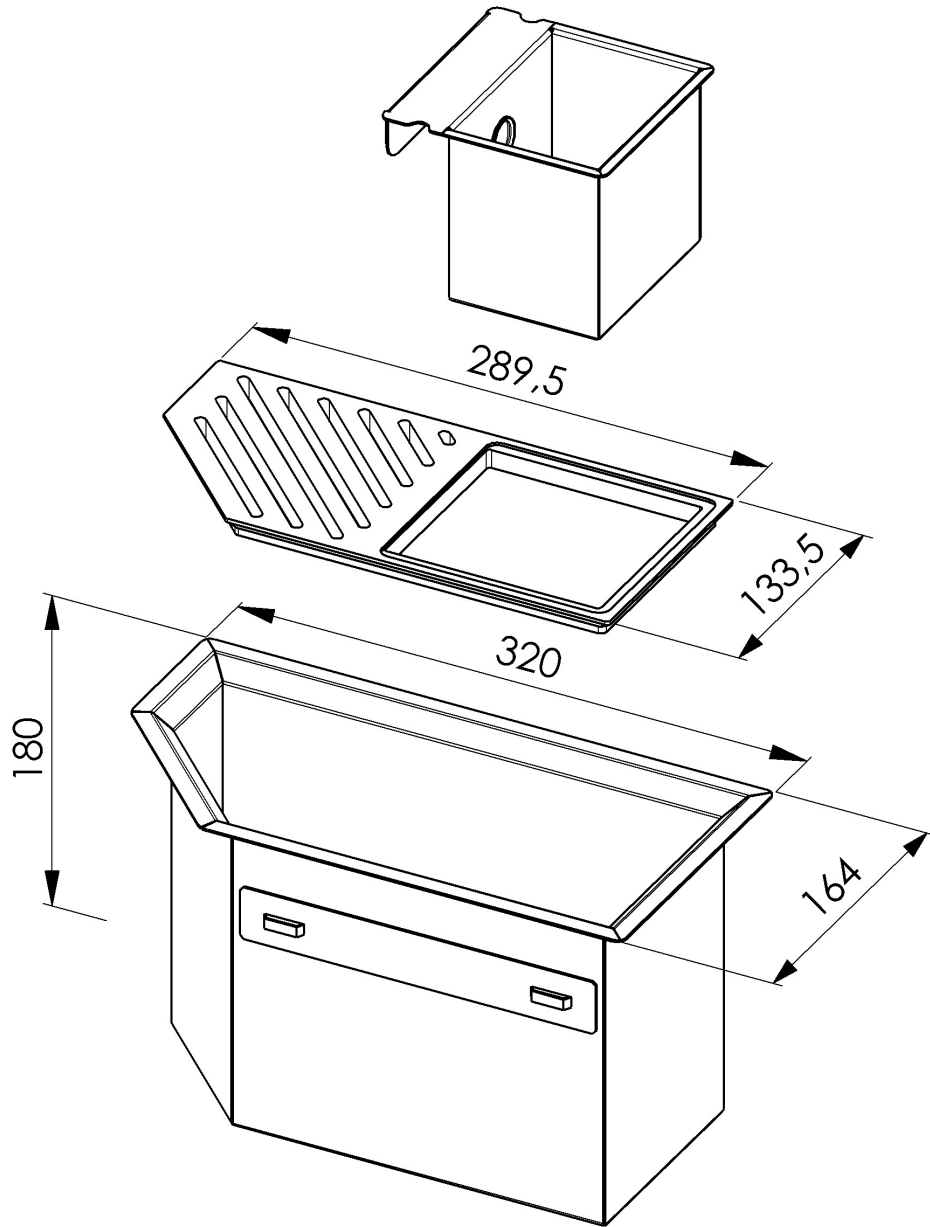

1 x Supporto black / 1 x Black support
1 x Vaschetta AISI 304 / 1 x AISI 304 tray

GALLERY

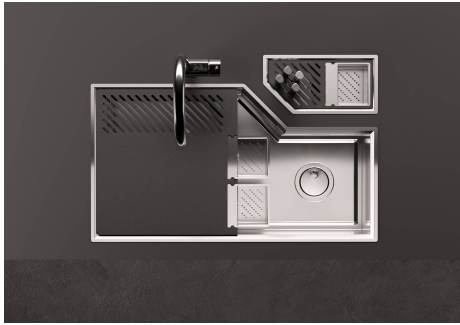

RECOMMENDED PAIRINGS



Sink Diade Gun Metal
3028 006



Sink Diade Gun Metal
3028 856